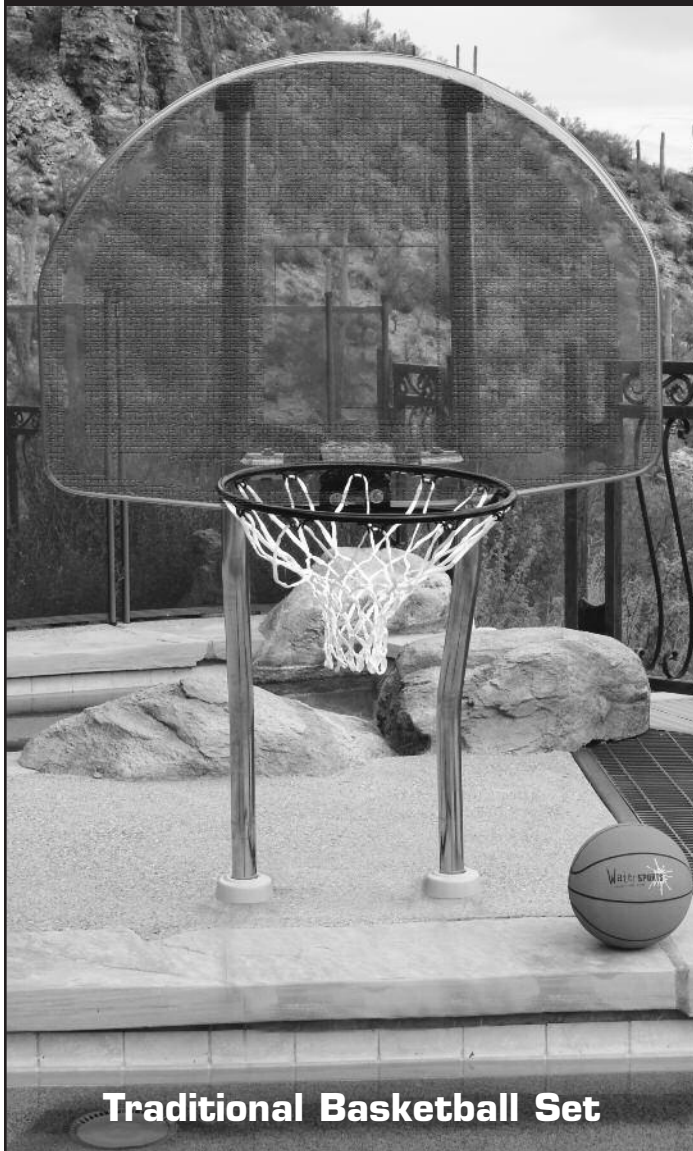




## Traditional & Pro Style Basketball Set Assembly & Installation Instructions



**Traditional Basketball Set**



**Pro Style Basketball Set**

3050 S. ALVERNON WAY • TUCSON, AZ 85713  
520.790.7040 • 800.737.5386 • FAX 520.790.7127

***inter-fab.com***

**TABLE OF CONTENTS:**

*(Applies to both Traditional & Pro Style Models)*

Intended Use Instructions ..... 1

In Deck/In Ground Installation.....2-4

On Deck Installation .....5-7

Backboard Exploded View..... 8

Inter-Fab Limited Warranty.....9

**LIST OF REQUIRED TOOLS**

Tools required for assembly and installation of Basketball Sets:

***NOTE: USE PROVIDED ANTI-SEIZE ON ALL BOLTS!***

**POLE SET / BACKBOARD:**

- 3/8" Drive Ratchet
- 3/8" x 6" Ratchet Extension
- 1/2" Socket
- 9/16" Socket
- 1/2" Combination Wrench
- 9/16" Combination Wrench

**ON DECK INSTALL: *(in addition to above)***

- Hammer Drill
- 3/8" Masonry Bit
- 7/16" Socket
- 7/16" Combination Wrench

**BRONZE ANCHOR CAP: *(for in deck install with Bronze Anchor)***

- Phillips Head Screw Driver

** WARNING IMPORTANT INSTALLATION INFORMATION**

The installation of this product should be done only by a licensed and professional installer. Installation should be done strictly in conformance with all local building codes, electrical codes and other building and safety laws and regulations. Among other things, that your installer should carefully analyze the need to bond the product to prevent an electrical hazard. Failure to properly install this product could result in a dangerous condition, including but not limited to electrical or structural hazards. Inter-Fab, Inc. disclaims all liability arising from the installation and the user assumes all risk associated with the installation.

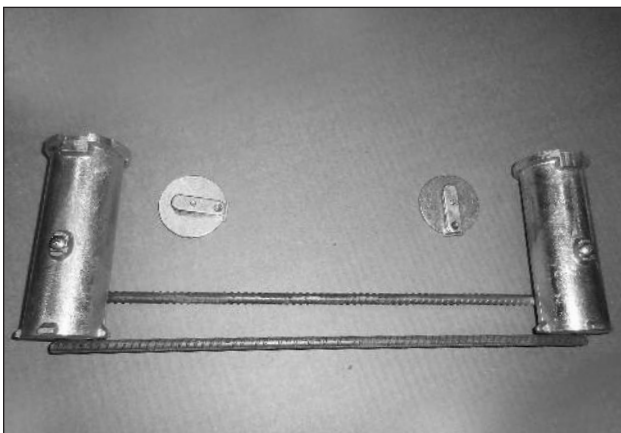
**! WARNING INTENDED USE INSTRUCTIONS**

1. Everyone who uses this Pool Games game set must know, understand and follow these instructions.
2. This game set is designed for residential in ground pool use only. This game set may not be used on any above ground pool. Such use of this game set may result in serious injury or death.
3. This game set should never be installed on above ground pools, ponds, floating docks or platforms, boat docks or houseboats or any natural body of water.
4. This game set should never be installed on any commercial, public or semi-public pool.
5. Be familiar with the shape and depth of the pool before you install the game set. This game set should only be used in the shallow end of the pool.
6. Take caution not to wear any objects or jewelry that may become entangled in the net. Rings, bracelets, necklaces, watches, etc. should be removed prior to play.
7. Do not climb on or hang from game set support poles, rim or net.
8. Do not stand, jump or dive from any part of the game set.
9. No roughhousing or horseplay should be allowed during game play at any time.
10. Do not use this game set if physically impaired or handicapped without your doctor's permission.
11. Do not use this game set with a history of heart conditions, seizures, back problems, or fainting.
12. Do NOT use this game set if you are pregnant.
13. Do not drink alcohol and use this game set.
14. Don't take chances, inspect the game set at least once a year for parts that may become loose, damaged, weakened or broken. If necessary, before using the game set again, have it inspected and repaired by a competent professional familiar with pool game sets.
15. When removing the game set support posts (in deck installations only), be sure to put the anchor caps in place over the holes. This will prevent any possible injury and from debris from falling into the hole.

**! WARNING: SERIOUS INJURY OR DEATH CAN RESULT FROM THE IMPROPER INSTALLATION OR USE OF THIS GAME SET.**

**INSTALLATION PREFACE**

**NOTE:** There are 2 anchor styles available for the in deck Basketball game set, bronze anchor jig with bronze anchor caps or plastic anchor jig with rebar and black plastic anchor caps. (See Fig. 1 & Fig. 2 for reference.)



**Fig. 1**  
*Bronze Anchor Jig for In Deck Installation*



**Fig. 2**  
*Plastic Anchor Jig for In Deck Installation*

## IN DECK INSTALLATION

### REQUIREMENTS:

To complete an in deck/in ground basketball game set installation, you will need Box #1, Box #2, and Box #4 **OR** Box #5 to fulfill the necessary parts required.

#### B-Ball Box #1 (backboard)

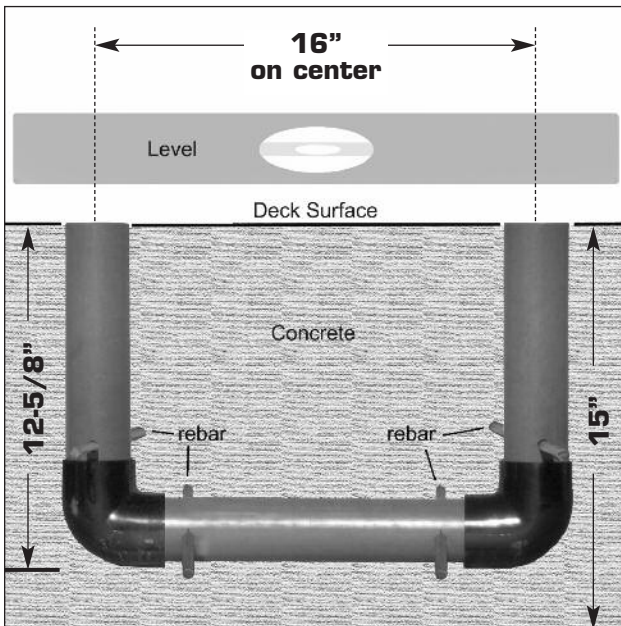
Includes backboard, rim, net, basketball, pump and rim to backboard hardware.

#### B-Ball Box #2 (in deck pole set)

Includes 2 in deck poles, pole cross piece, escutcheons and assembly hardware kit (H-BB-101).

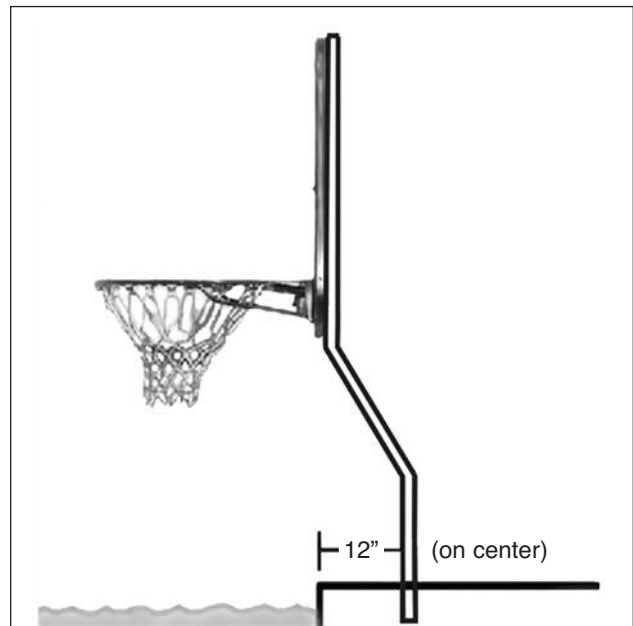
#### B-Ball Box #4 (bronze anchor jig) - See Fig. 1

#### B-Ball Box #5 (plastic anchors jig with rebar) - See Fig. 2



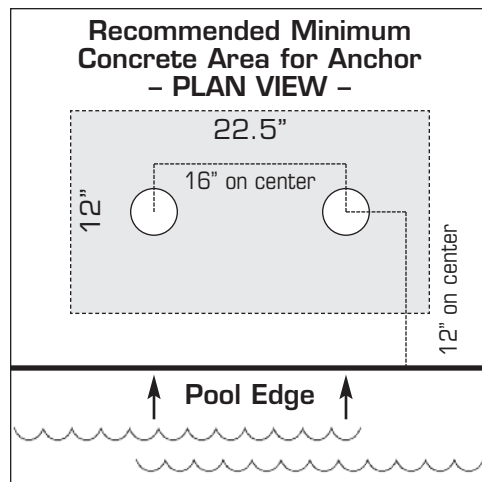
**Fig. 3**

*Example Anchor Placement in Concrete*



**Fig. 4**

*Anchor Placement - Side View*



**Fig. 5**

*Anchor Placement - Plan View*



**Fig. 6**

*Support Poles*



**STEP ONE:** Basketball poles must be anchored into deck with either the bronze 6" anchor jig (welded @ 16" on center) or the plastic anchor jig (glued @ 16" on center). Position the anchor 12" back from edge of the pool (as shown in Fig. 4) on the shallow end of the pool. Anchor must be level on both axis and flush with the finished deck surface (as shown in Fig. 3).

**NOTE:** Recommended minimum concrete area for anchors (as shown in Fig. 5). Ground the bronze anchor (if used) in accordance with the local codes. Insert rebar (4 each) through holes of plastic anchor (if used).

Both anchors are supplied with caps which can be used if the poles are removed.

**TIP:** Ensure that no concrete is allowed to spill into anchors.

**NOTE: CONCRETE MUST FULLY CURE BEFORE POLES ARE INSERTED INTO ANCHORS. THE MINIMUM RECOMMENDED CONCRETE DEPTH FOR EITHER ANCHOR IS 15".**

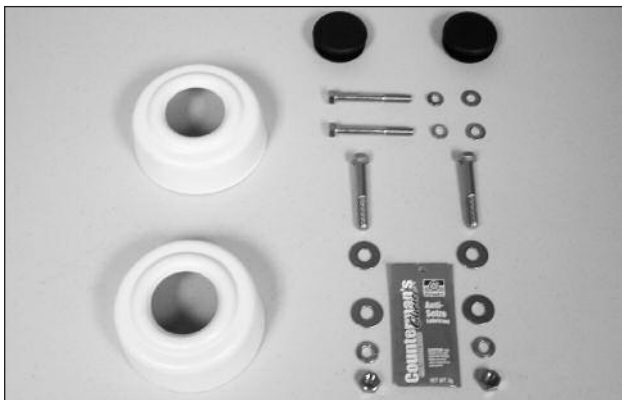
**AT THIS TIME, REMOVE PROTECTIVE FILM FROM BACKBOARD.**

**STEP TWO:** Attach the rim and cross brace to the backboard. (See Fig. 9) For a one man installation, place the backboard face down on cardboard on a flat stable surface, overhang the board about 4". Align the 2 rubber rim bushings with the holes in the backboard. NOTE: bushing holes go up and down as shown.

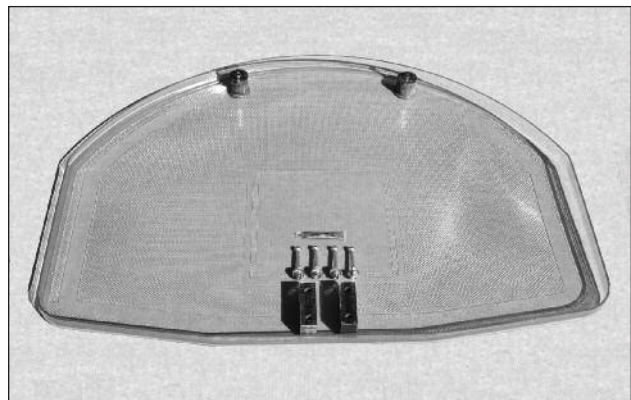
Orient rim correctly as shown, careful... do not place rim on upside down. Using hardware that came with backboard, place large washer over 5/16" x 3" bolt, add anti-seize to bolt, push bolt through rim bracket, backboard, then bushings (as shown in Fig. 9).

While holding the bolts from the bottom as shown, align the holes in the back cross brace with the bolts, place nut over bolts and finger tighten. Do the top 2 bolts first, then repeat the process for the bottom 2 bolts. (See Fig. 11)

**USE ANTI-SEIZE COMPOUND (PROVIDED) ON ALL BOLTS.**

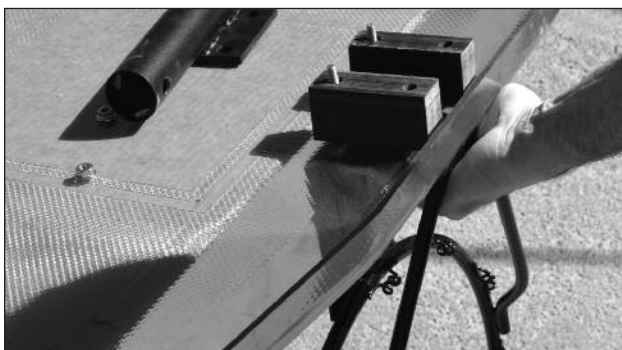


**Fig. 7**  
*Hardware Kit H-BB-101 Shown*

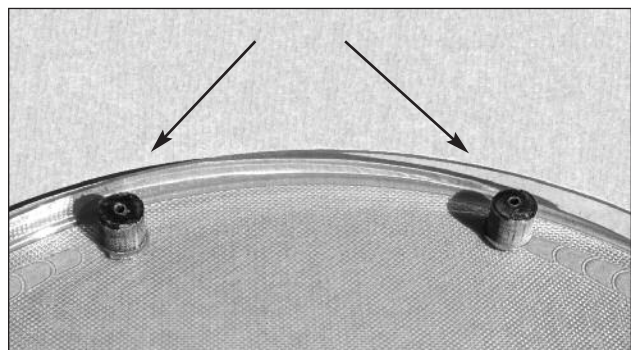


**Fig. 8**  
*Basketball Backboard and Hardware*

**STEP THREE:** Place backboard & rim on cardboard (as shown in Fig. 12), insert the 2 support poles over the black cross brace and align the holes. NOTE: the support poles are directional, insert them as shown. Using hardware kit H-BB-101, put washer over 3/8" x 2-1/2" bolt, add anti-seize to bolt, push bolt through holes to other side, place flat washer, lock washer, then nut. Finger tighten for now. (See Fig. 13)



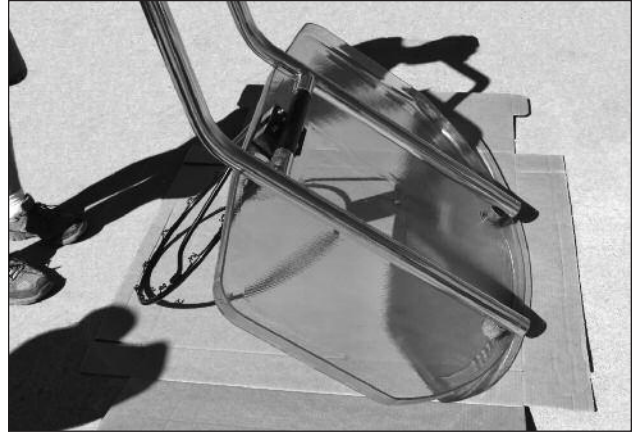
**Fig. 9**  
*Rim Assembly*



**Fig. 10**  
*Threaded PVC Bushings*



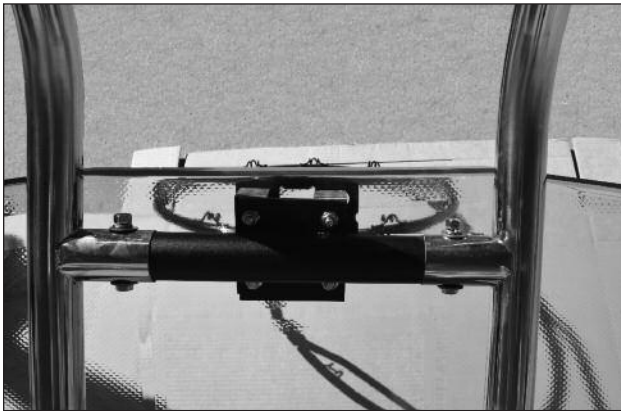
**Fig. 11**  
*Crossbrace Assembly*



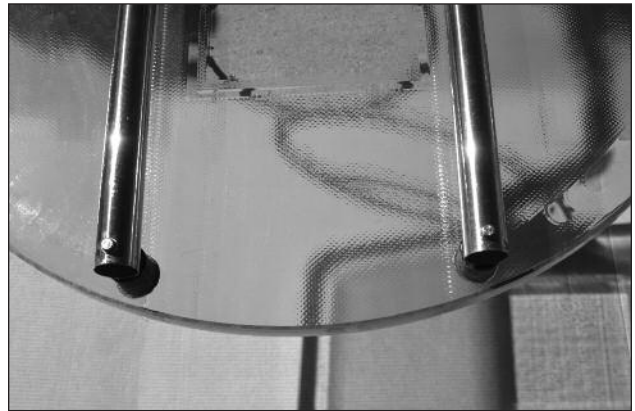
**Fig. 12**  
*Support Pole Assembly*

**STEP FOUR:** Align holes in top of poles with Threaded PVC Bushings (See Fig. 10), use the 5/16" x 2-3/4" bolt with small washer that are included in the H-BB-101 hardware kit that came with your support poles, add anti-seize to bolt, by hand, screw bolt into threads in PVC bushing, **be careful not to cross thread or over tighten bolts or you will strip the threads and void the warranty.** (See Fig. 14) **Do not over tighten.**

**STEP FIVE:** Place an escutcheon over each anchor socket. Stand backboard and pole assembly upright and slide poles through escutcheons and into deck anchors. Tighten all hardware at this time. Place black caps on top of each support pole and install net on rim. (See Fig. 15 & 16)



**Fig. 13**  
*Support Poles Over Crossbrace*



**Fig. 14**  
*Support Poles Over PVC Bushings*



**Fig. 15**  
*Complete Traditional System*



**Fig. 16**  
*Complete Pro Style System*

## ON DECK INSTALLATION

### REQUIREMENTS:

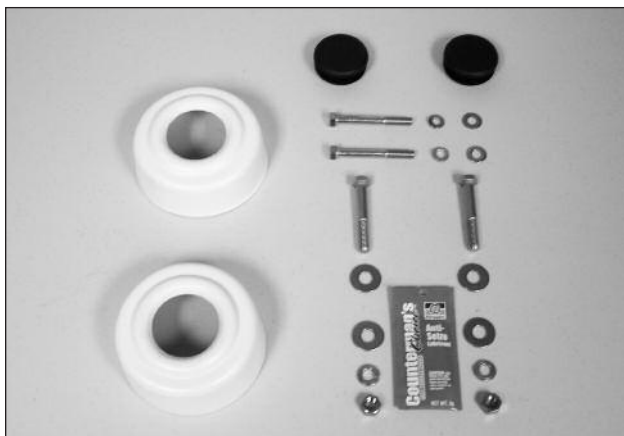
To complete an on deck/above ground basketball game set installation, you will need Box #1 and Box #3.

#### B-Ball Box #1 (backboard)

Includes backboard, rim, net, basketball, pump and rim to backboard hardware.

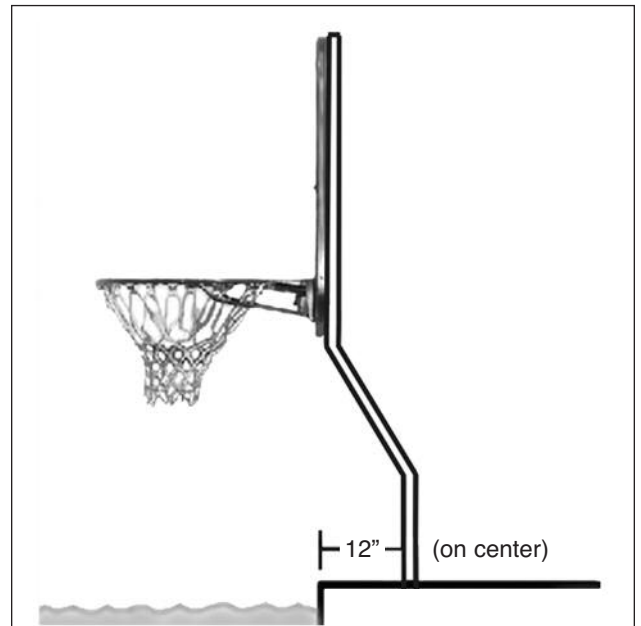
#### B-Ball Box #3 (on deck pole set)

Includes 2 on deck poles, 2 (two) 9" deck anchors, pole cross piece, escutcheons and assembly hardware kits H-BB-101 and WS-DM.



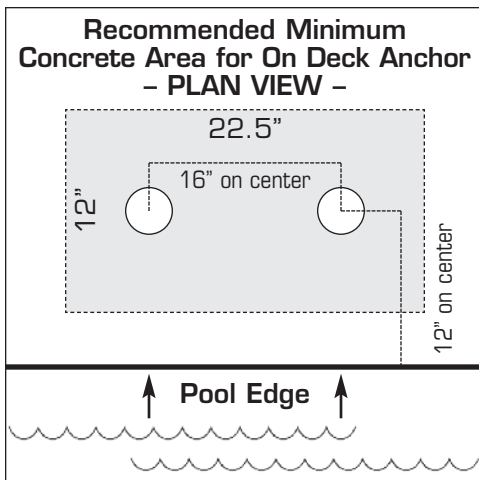
**Fig. 17**

Hardware Kit H-BB-101 Shown



**Fig. 18**

Anchor Placement - Side View



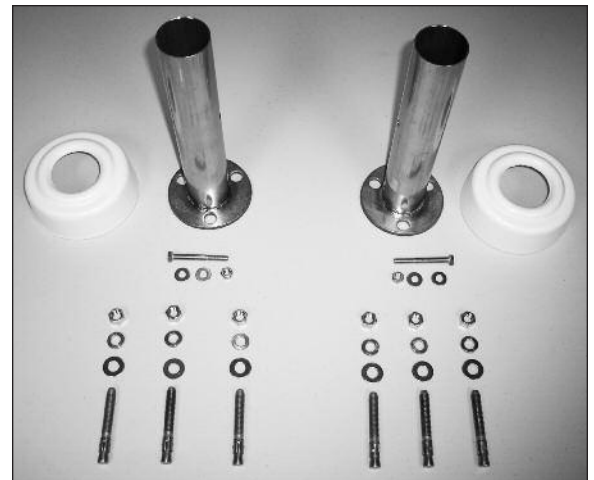
**Fig. 19**

Anchor Placement - Plan View



**Fig. 20**

Support Poles



**Fig. 21**

Kit WS-DM: On Deck Anchors, Escutcheons, Hardware

**NOTE: DECK MUST BE SOUND CONCRETE AND AT LEAST 4" THICK FOR ON DECK INSTALLATION.**

**STEP ONE:** Locate a suitable location for Basketball unit. Poles must be anchored on the pool deck with 2 each 3-hole flange deck anchors provided. (See Fig. 21) The deck anchors will be installed 12" back from edge of pool (as shown in Fig. 18) on the shallow end of the pool. Detailed instructions will follow in Step 6.



**AT THIS TIME REMOVE PROTECTIVE FILM FROM BACKBOARD.**

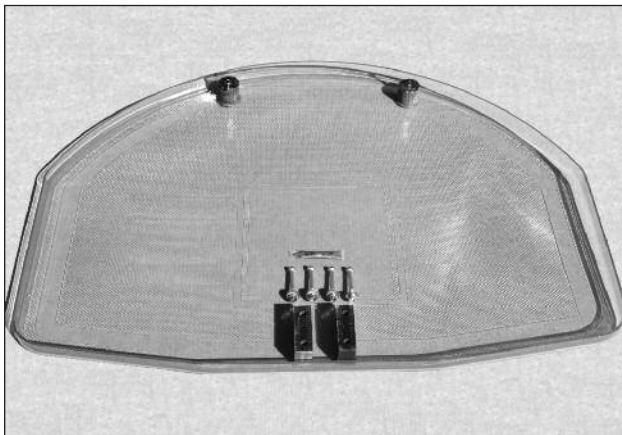
**STEP TWO:** Attach the rim and cross brace to the backboard. (See Fig. 23) For a one man installation, place the backboard face down on cardboard on a flat stable surface, overhang the board about 4". Align the 2 rubber rim bushings with the holes in the backboard. NOTE: bushing holes go up and down as shown.

Orient rim correctly as shown, careful... do not place rim on upside down. Using hardware that came with backboard, place large washer over 5/16" x 3" bolt, add anti-seize to bolt, push bolts through rim bracket, backboard, then bushings as shown.

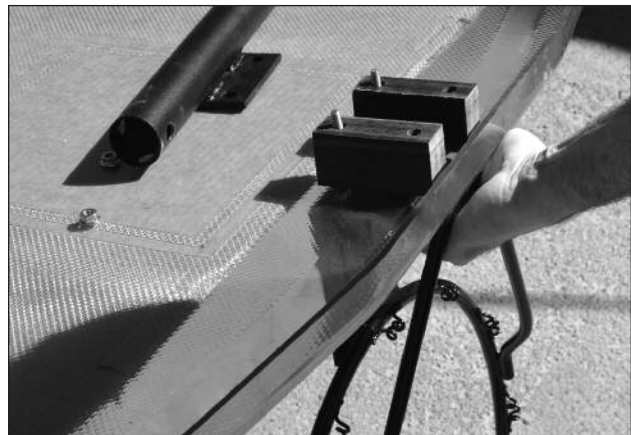
While holding the bolts from the bottom as shown, align the holes in the back cross brace with the bolts, place nut over bolts and finger tighten. Do the top 2 bolts first, then repeat the process for the bottom 2 bolts. (See Fig. 24)

**USE ANTI-SEIZE COMPOUND (PROVIDED) ON ALL BOLTS.**

**STEP THREE:** Place backboard & rim on cardboard (as shown in Fig. 25), insert the 2 support poles over the black cross brace and align the holes. NOTE: the support poles are directional, insert them as shown. Use hardware kit H-BB-101, put washer over 3/8" x 2-1/2" bolt, add anti-seize to bolt, push bolt through holes to other side, place flat washer, lock washer, then nut. Finger tighten for now. (See Fig. 26)



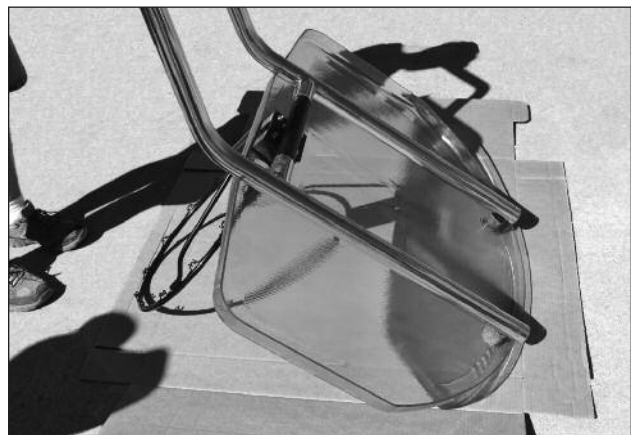
**Fig. 22**  
*Basketball Backboard with Hardware*



**Fig. 23**  
*Rim Assembly*



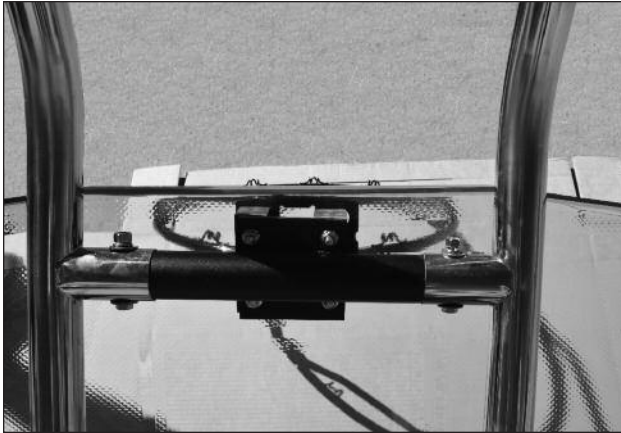
**Fig. 24**  
*Crossbrace Assembly*



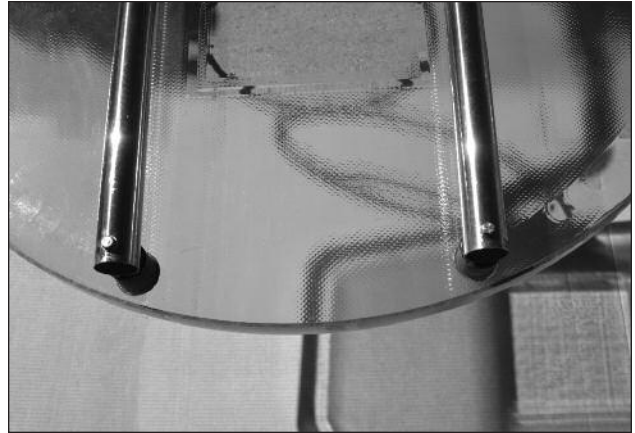
**Fig. 25**  
*Support Pole Assembly*

**STEP FOUR:** Align holes in top of poles with Threaded PVC Bushings (See Fig. 27), use the 5/16" x 2-3/4" bolt with small washer that are included in the H-BB-101 hardware kit that came with your support poles, add anti-seize to bolt, by hand, screw bolt into threads in PVC bushing, **be careful not to cross thread or over tighten bolts or you will strip the threads and void the warranty. Do not over tighten.**





**Fig. 26**  
*Support Poles Over Crossbrace*



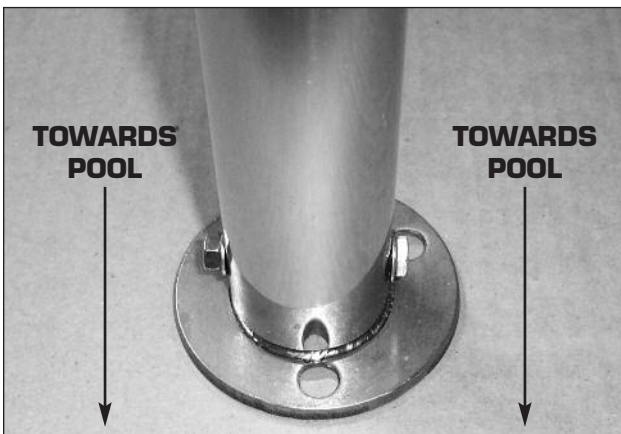
**Fig. 27**  
*Support Poles Over PVC Bushings*

**STEP FIVE:** Place an escutcheon on each deck pole, insert a deck anchor onto the bottom of each support pole bottom. Orient deck anchors on poles (as shown in Fig. 28) so the single deck flange hole is facing toward the pool and the other 2 holes in the deck flange are facing away from the pool.

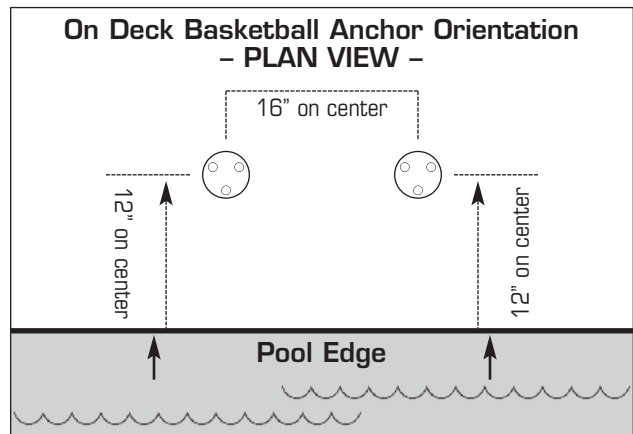
Secure the flanges to support poles, using hardware kit H-BB-101, pass the 1/4" x 2-1/4" bolt through the holes using a flat washer on each side of the post and hand tighten the nut. (Fig. 28)

**STEP SIX:** With 2 people, carefully stand the basketball assembly upright and in position on the deck. (See Fig. 29) None of the fasteners are tight at this point, so the assembly will have some flexibility. Make sure the set back from pool edge is 12" and the distance between poles is 16" **on center**. Mark the 3 flange hole locations for each pole. Move the assembly and using a 3/8" masonry bit, drill each hole 2" deep. Clean out each hole with water to allow wedge anchors to fully recess the full 2", use 3/8" wedge anchors supplied in kit WS-DM. (See Fig. 21) Align deck flanges over wedge anchors and secure the anchor with flat washer, locker washer and 3/8" nut.

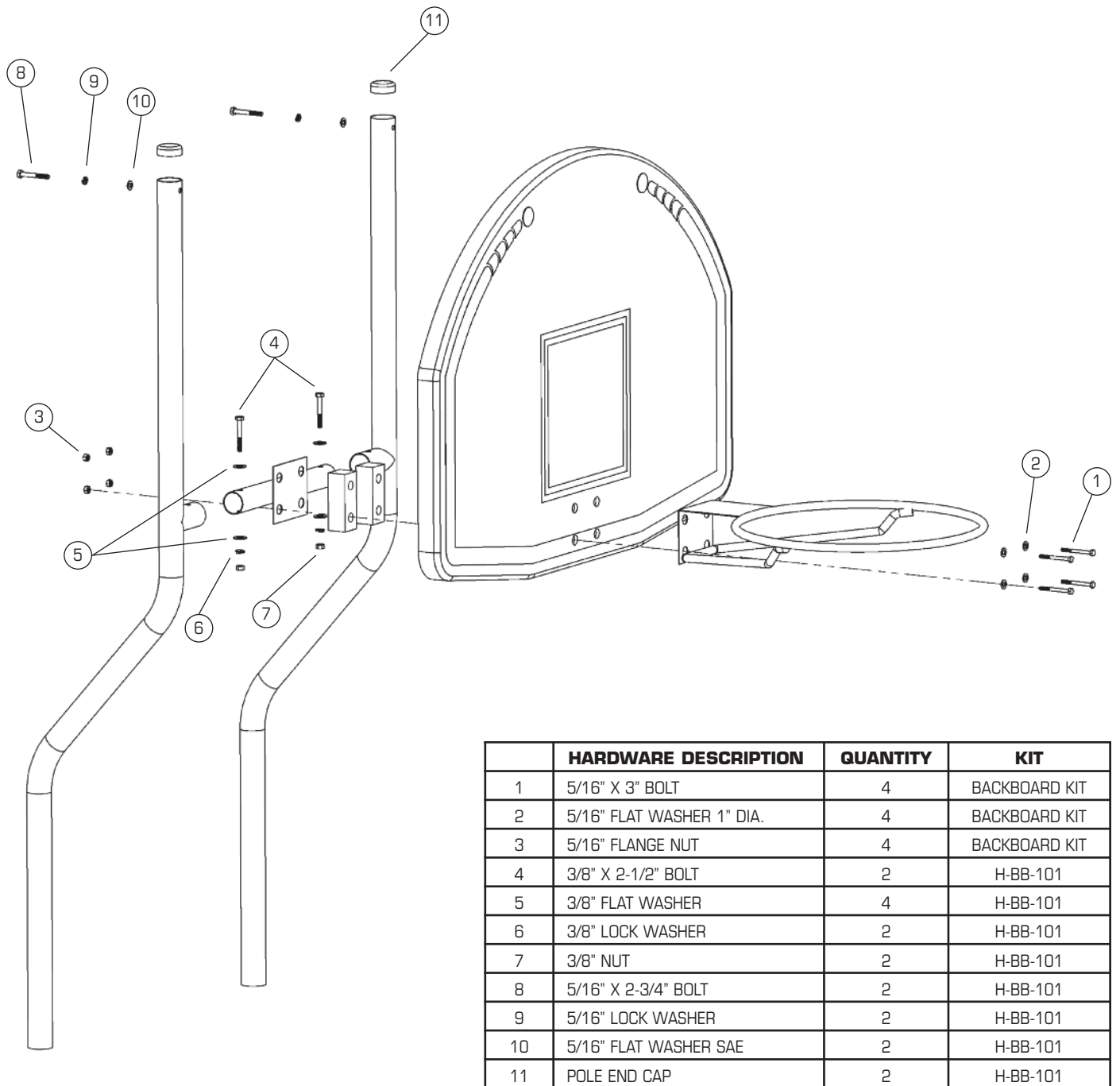
**STEP SEVEN:** Tighten all hardware at this time. Place black caps on top of each support pole and install net on rim. (See Fig. 15 & 16)



**Fig. 28**  
*On Deck Anchor with Flange*

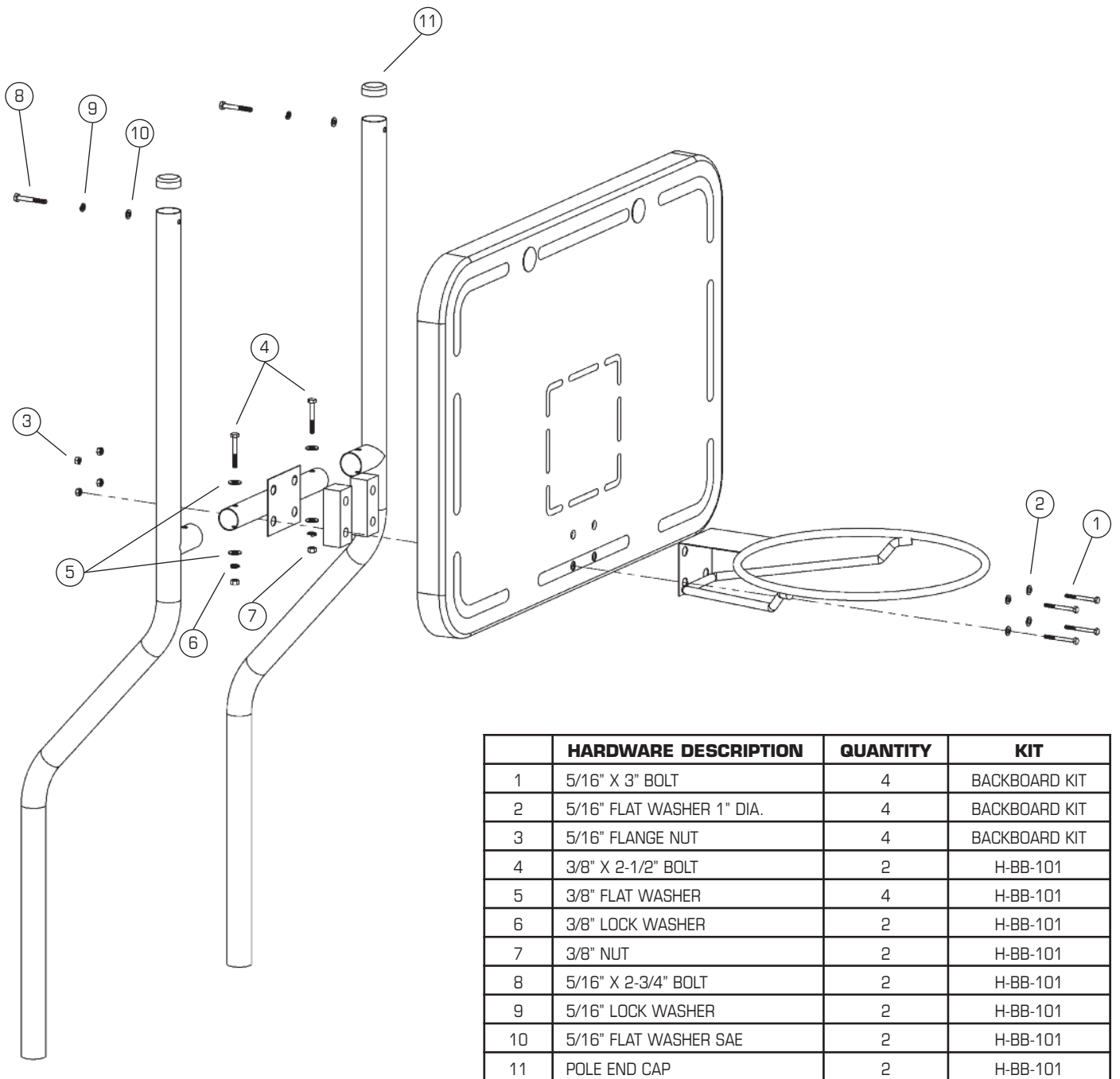


**Fig. 29**  
*On Deck Anchor Orientation*



	<b>HARDWARE DESCRIPTION</b>	<b>QUANTITY</b>	<b>KIT</b>
1	5/16" X 3" BOLT	4	BACKBOARD KIT
2	5/16" FLAT WASHER 1" DIA.	4	BACKBOARD KIT
3	5/16" FLANGE NUT	4	BACKBOARD KIT
4	3/8" X 2-1/2" BOLT	2	H-BB-101
5	3/8" FLAT WASHER	4	H-BB-101
6	3/8" LOCK WASHER	2	H-BB-101
7	3/8" NUT	2	H-BB-101
8	5/16" X 2-3/4" BOLT	2	H-BB-101
9	5/16" LOCK WASHER	2	H-BB-101
10	5/16" FLAT WASHER SAE	2	H-BB-101
11	POLE END CAP	2	H-BB-101

**Fig. 30**  
Exploded View of All Parts for Traditional Basketball Set



**Fig. 31**  
Exploded View of All Parts for Pro Style Basketball Set



## LIMITED WARRANTY

**Inter-Fab, Inc.** will repair or replace, at its option, any product manufactured by Inter-Fab, Inc. that fails during the applicable warranty period because of a manufacturing or material defect; provided that the defect is not the result of improper installation, improper use or care, negligence, alterations or modifications to the product, or natural accidents (acts of God). The applicable warranty period for products manufactured by Inter-Fab, Inc. is three (3) years from the date of retail purchase, except as specified below:

**Water Sports™** sports equipment warranty periods are as follows: Volleyball Poles, Basketball Poles, Basketball Rim, and Basketball Backboard are one (1) year from date of retail purchase. Volleyball, Volleyball Net, Basketball, Basketball Net, and pumps are warranted for ninety (90) days from date of retail purchase.

The **Board Fall** used for the **T7™** and **aquaBoard™** products, have a warranty period of one (1) year from the date of retail purchase.

**Zoomerang™** slide products warranty period is one (1) year from the date of retail purchase.

**Build Your Own Slide™** (BYOS™), **Build Your Own Slide 2™** (BYOS 2™), **Garden Ride Series™\***, **River Run Series™\***, **Rock-r-Lounger™**, **Pool/Spa Table™**, and **Pool/Spa Seat™** products warranty periods are one (1) year from the date of retail purchase.

**City 2™ Slide** and **City Base™** products warranty period are one (1) year from the date of retail purchase.

Unless expressly stated otherwise all products manufactured by Inter-Fab are for **residential installation (single family residence)** inground pool use only. Inter-Fab, Inc. expressly disclaims any and all warranties and liability arising from the installation or use of its residential products for any non-residential use such as semi-public, public, or commercial applications. Products expressly manufactured for commercial installation and use will be subject to this limited warranty.

This limited warranty is in lieu of all other warranties, whether express or implied. Inter-Fab, Inc. disclaims any warranty of merchantability or fitness for a particular use, and noninfringement in relation to any of its products and Inter-Fab, Inc. is not liable for consequential, incidental or specific damages. This warranty is limited to the repair or replacement of the manufacturing or material defect, or refund of the original purchase price, whichever is less, at the sole option of Inter-Fab, Inc., and expressly does not cover any labor or reinstallation expenses related to the replacement of any and all Inter-Fab products. This limited warranty shall be the sole and exclusive remedy of irrespective of whether the claims are made in contract, tort, warranty, law, equity or by statute.

This warranty is to the original purchaser of the product only. Inter-Fab's limited warranty is neither transferable nor portable from consumer to consumer. The effective coverage date begins at the date of retail purchase. Product owner or representative must notify Inter-Fab, Inc. (or its wholesale agent) in writing, giving a full description of the nature of the product defect or failure along with proof of purchase, serial number(s) of the product and photos within thirty (30) days of the expiration of the applicable warranty period. Inter-Fab, Inc. reserves the right to physically inspect damaged or defective products or components to determine the cause of the damage or defect, prior to authorizing repair or replacement of its products.

\* Please see specific warranty information for the Garden Ride Series and River Run Series slides.



**3050 S. ALVERNON WAY • TUCSON, AZ 85713**  
**520.790.7040 • 800.737.5386 • FAX 520.790.7127 • INTER-FAB.COM**