

inter-fab
.COM

**18"
SETBACK
MODEL**

BASKETBALL SET

Assembly & Installation Instructions



3050 S. ALVERNON WAY • TUCSON, AZ 85713
520.790.7040 • 800.737.5386 • FAX 520.790.7127

inter-fab.com

TABLE OF CONTENTS:

Intended Use Instructions 1

In Deck/In Ground Installation.....2-4

On Deck Installation5-7

Backboard Exploded View 8

Inter-Fab Limited Warranty..... 9

LIST OF REQUIRED TOOLS

Tools required for assembly and installation of Basketball Set:

NOTE: USE PROVIDED ANTI-SEIZE ON ALL BOLTS!

BRONZE ANCHOR CAP:

Phillips Head Screw Driver

POLE SET / BACKBOARD:

- 3/8" Drive Ratchet
- 3/8" x 6" Ratchet Extension
- 1/2" Socket
- 9/16" Socket
- 1/2" Combination Wrench
- 9/16" Combination Wrench
- 3/4" Combination Wrench

ON DECK INSTALL:

- Hammer Drill
- 3/8" Masonry Bit
- 7/16" Socket
- 7/16" Combination Wrench

INTENDED USE INSTRUCTIONS

1. Everyone who uses this Water Sports™ game set must know, understand and follow these instructions
2. This game set is designed for residential in ground pool use only. This game set may not be used on any above ground pool. Such use of this game set may result in serious injury or death.
3. This game set should never be installed on above ground pools, ponds, floating docks or platforms, boat docks or houseboats or any natural body of water.
4. This game set should never be installed on any commercial, public or semi-public pool.
5. Be Familiar with the shape and depth of the pool before you install the game set. This game set should only be used in the shallow end of the pool.
6. Take caution not to wear any objects or jewelry that may become entangled in the net. Rings, bracelets, necklaces, watches, etc. should be removed prior to play.
7. Do not climb on or hang from game set support poles or net.
8. Do not stand, jump or dive from any part of the game set.
9. No roughhousing or horseplay should be allowed during game play at any time.
10. Do not use this game set if physically impaired or handicapped without your doctor's permission.
11. Do not use this game set with a history of heart conditions, seizures, back problems, or fainting.
12. Do NOT use this game set if you are pregnant.
13. Do not drink alcohol and use this game set.
14. Don't take chances, inspect the game set at least once a year for parts that may become loose, damaged, weakened or broken. If necessary, before using the game set again, have it inspected and repaired by a competent professional familiar with pool game sets.
15. When removing the game set support posts (in deck installations only), be sure to put the anchor caps in place over the holes. This will prevent any possible injury and from debris from falling into the hole.

WARNING: SERIOUS INJURY OR DEATH CAN RESULT FROM THE IMPROPER INSTALLATION OR USE OF THIS GAME SET.

INSTALLATION PREFACE

NOTE: There are 2 anchor styles available for the in deck Basketball game set, 1) bronze anchor jig with bronze anchor caps or 2) plastic anchor jig with rebar and black plastic anchor caps. (See Fig. 1 & Fig. 2 for reference.)

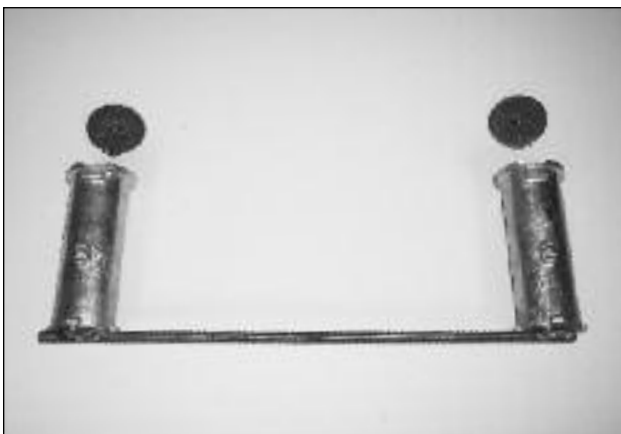

Fig. 1
Bronze Anchor Jig for In Deck Installation



Fig. 2
Plastic Anchor Jig for In Deck Installation

IN DECK INSTALLATION

REQUIREMENTS:

To complete an in deck/in ground basketball game set installation, you will need Box #1, Box #2, and Box #4 **OR** Box #5 to fulfill the necessary parts required.

B-Ball Box #1 (backboard)

Includes backboard, rim, net, basketball, pump and rim to backboard hardware.

B-Ball Box #2 (in deck pole set)

Includes 2 in deck poles, pole cross piece, escutcheons and assembly hardware.

B-Ball Box #4 (bronze anchor jig) - See Fig. 1

B-Ball Box #5 (plastic anchors jig with rebar) - See Fig. 2

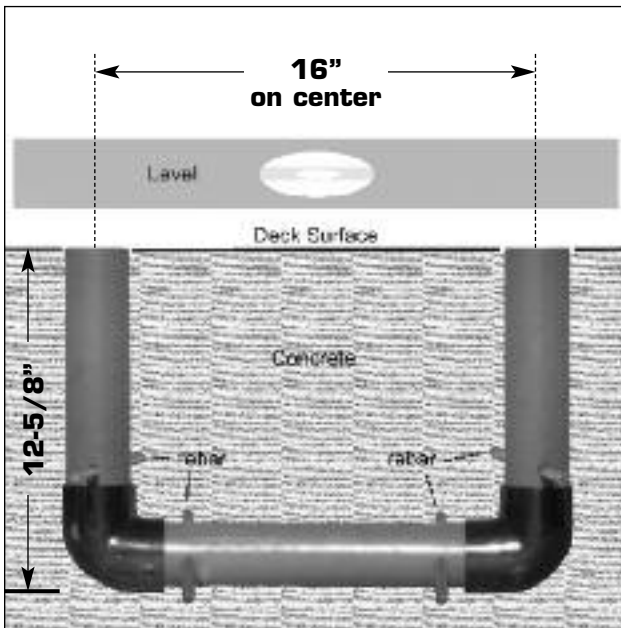

Fig. 3

Example Anchor Placement in Concrete

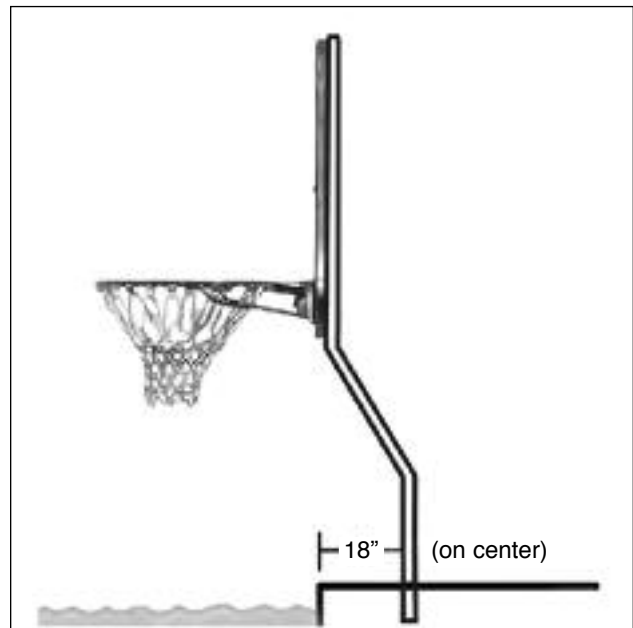

Fig. 4

Anchor Placement - Side View

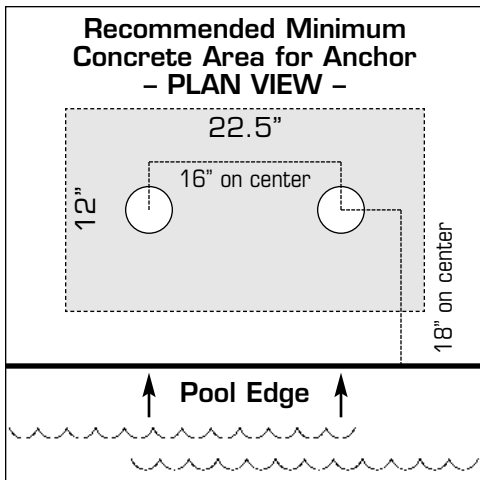

Fig. 5

Anchor Placement - Plan View

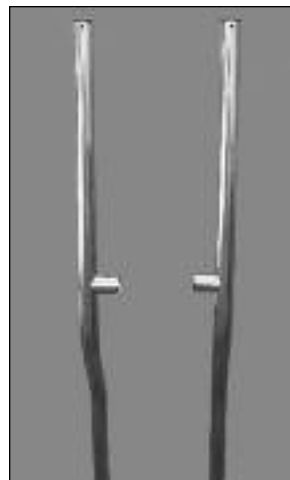

Fig. 6

Support Poles

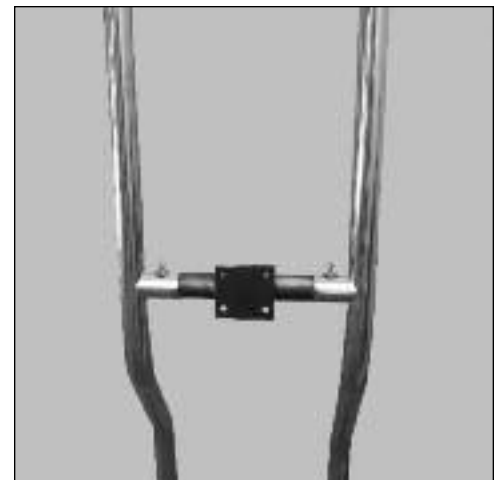

Fig. 7

Support Poles with Cross Brace

STEP ONE: Basketball poles must be anchored into deck with either the bronze 6" anchor jig (welded @ 16" on center) or the plastic anchor jig (glued @ 16" on center). Position the anchor 18" back from edge of the pool (as shown in Fig. 4) on the shallow end of the pool. Anchor must be level on both axis and flush with the finished deck surface as shown in Fig. 3.

NOTE: Recommended minimum concrete area for anchors is shown in Fig. 5. Ground the bronze anchor (if used) in accordance with the local codes. Insert rebar (4 each) through holes of plastic anchor (if used).

Both anchors are supplied with caps which can be used if the poles are removed.

TIP: Ensure that no concrete is allowed to spill into anchors.

NOTE: CONCRETE MUST FULLY CURE BEFORE POLES ARE INSERTED INTO ANCHORS. THE MINIMUM RECOMMENDED CONCRETE DEPTH FOR EITHER ANCHOR IS 15".

STEP TWO: Attach the cross brace to the support posts (see Fig. 6) by inserting the cross brace inside the 2 support post stubs. (See Fig. 7) The square 4-hole plate on the cross brace faces the pool. Insert the two (2) 3/8" bolts through the holes adding a flat washer top and bottom of cross piece and then lock washer and nut. Hand tighten only.

TIP: Use anti-seize compound (provided) on all bolts. At this time, remove protective film from backboard.

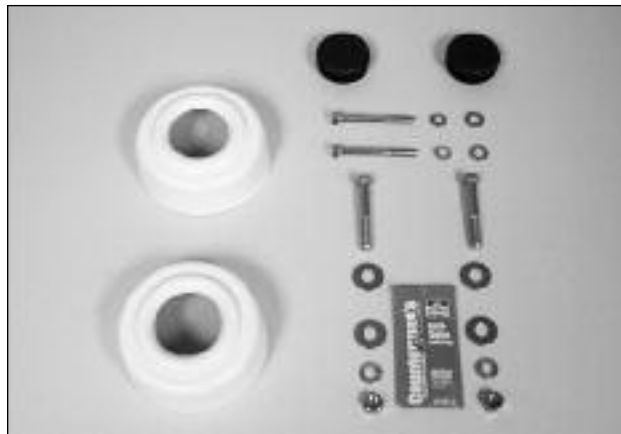

Fig. 8

Hardware Kit H-BB-101 Shown

STEP THREE: Attach the backboard to the 2 support posts by inserting the two (2) 5/16" bolts (Fig 9) through the uprights and into the 2 threaded insert nuts located on the top inside edge of the backboard (Fig 10), washer, lock washer and nut; hand tighten. Performing this step on the ground may prove to be easier. To eliminate scratching place the box on the ground first. Use a flat washer and lock washer for each bolt. (See Fig 30)

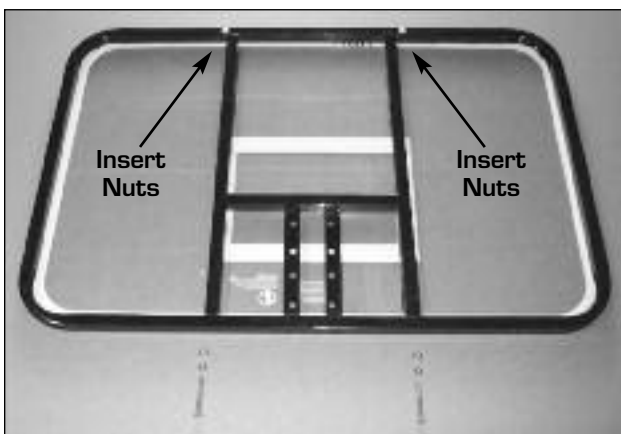

Fig. 9

Basketball Backboard

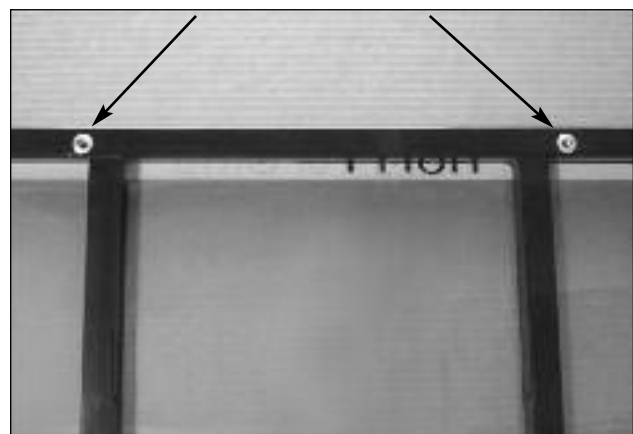

Fig. 10

Threaded Nuts Located on Top Inside Edge



Fig. 11

Support Poles Affixed to Threaded Insert Nuts

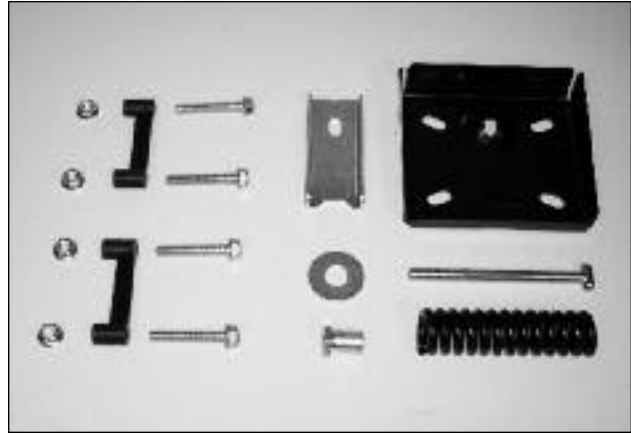

Fig. 12

Backboard Hardware Kit

STEP FOUR: (Requires hardware from B-Ball box #1 - See Fig. 12) Pass 3/8" x 5" T bolt through back side of Slam Jam bracket. "T" part of bolt will nestle in indentation of bracket. Align the 4 holes in this assemble with the 4 matching holes in backboard. Pass four (4) 5/16" x 2" bolts through from front. After bolts pass through backboard but before cross piece, insert a plastic spacer on each side. After cross piece, attach four (4) 5/16" hex flange nuts. (See Fig. 13) Hand tighten only.

STEP FIVE: Pass 3/8" x 5" T bolt through center hole of rim. Install Slam Jam reinforcement bracket next on T bolt. (Bent part of bracket faces rim and flat part faces spring.) The rim spring is added next, followed by the 1-1/2" washer, then the special 3/8" nut. (See Fig. 14) Install the net to the rim at this time.

NOTE: This assembly provides the breakaway feature of the rim and will be adjusted later in assembly.

STEP SIX: Place an escutcheon over each anchor socket. Stand backboard and pole assembly upright and slide poles through escutcheons and into deck anchors. Tighten all hardware at this time except the rim spring T bolt and nut. Place black caps on top of each support pole.

STEP SEVEN: Adjust rim tension by turning the special nut tighter on the T bolt. The adjustment range will be from bolt flush with top of nut (most tension) to bolt about 3/8" short of top of nut (least tension).



Fig. 13

T Bolt and Slam Jam Bracket Shown



Fig. 14

Rim Installation Shown

ON DECK INSTALLATION

REQUIREMENTS:

To complete an on deck/above ground basketball game set installation, you will need Box #1 and Box #3.

B-Ball Box #1 (backboard)

Includes backboard, rim, net, basketball, pump and rim to backboard hardware.

B-Ball Box #3 (on deck pole set)

Includes 2 on deck poles, 2 (two) 9" deck anchors, pole cross piece, escutcheons and assembly hardware.

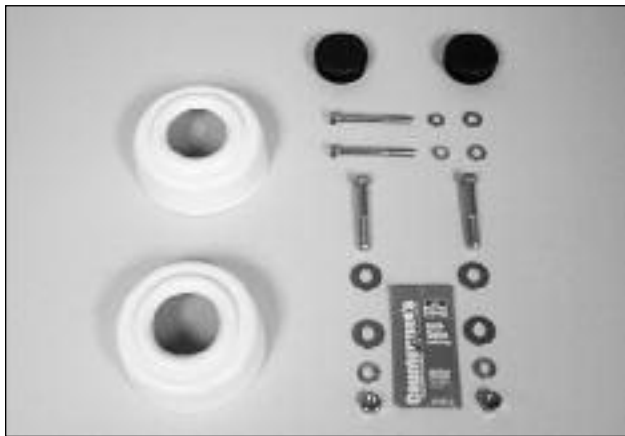

Fig. 15
Hardware Kit H-BB-101 Shown



Fig. 16
Anchor Placement - Side View

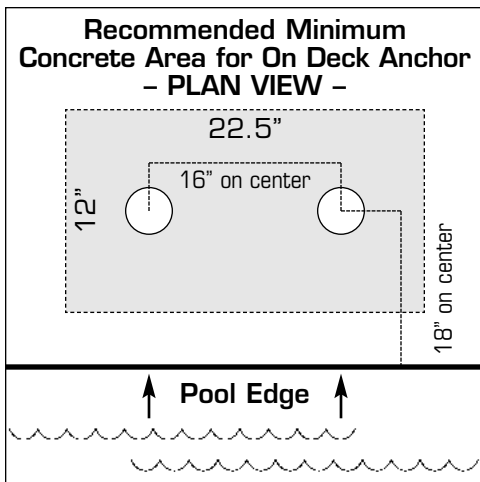

Fig. 17
Anchor Placement - Plan View



Fig. 18
Support Poles

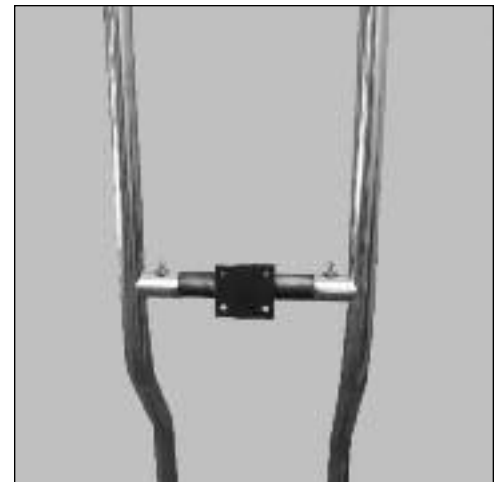

Fig. 19
Support Poles with Cross Brace

STEP ONE: Locate a suitable location for Basketball unit. Poles must be anchored on the pool deck with 3 hole flange deck anchors provided. the deck anchors will be installed 18" back from edge of pool (as shown in Fig. 16) on the shallow end of the pool. Detailed instructions will follow in Step 7.

NOTE: DECK MUST BE SOUND CONCRETE AND AT LEAST 4" THICK.

STEP TWO: Attach the cross brace to the support posts (See Fig. 18) by inserting the cross brace inside the 2 support post stubs (See Fig. 19). The square 4 hole plate on the cross brace faces the pool. Insert the two (2) 3/8" bolts through the holes adding a flat washer top and bottom of cross piece and then lock washer and nut. Hand tighten only.

Tip: Use anti-seize compound (provided) on all bolts. At this time, remove protective film from backboard.

STEP THREE: Attach the backboard to the 2 support posts by inserting the two (2) 5/16" bolts (Fig 20) through the uprights and into the 2 threaded insert nuts located on the top inside edge of the backboard (Fig 21), washer, lock washer and nut; hand tighten. Performing this step on the ground may prove to be easier. To eliminate scratching place the box on the ground first. Use a flat washer and lock washer for each bolt. (See Fig 30)

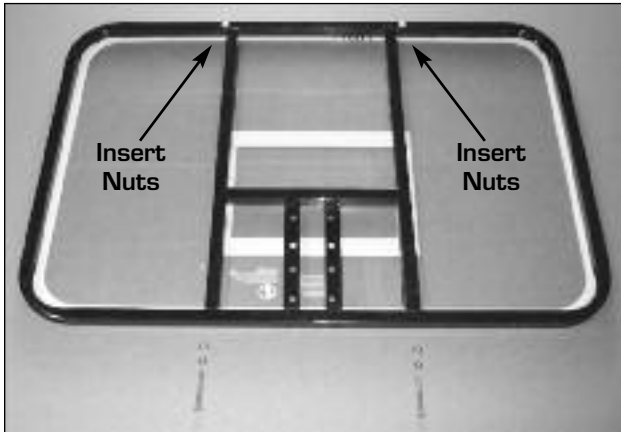

Fig. 20
Basketball Backboard

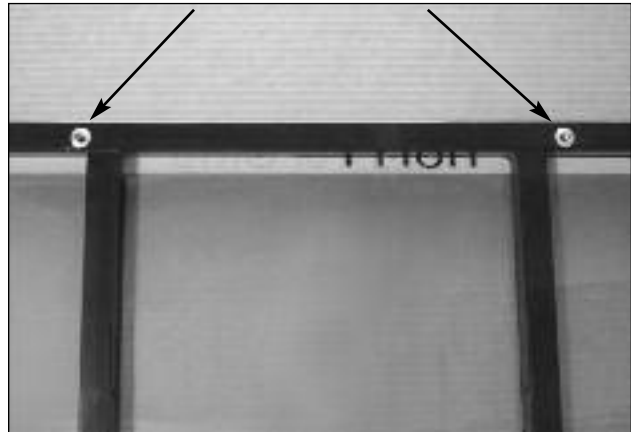

Fig. 21
Threaded Nuts Located on Top Inside Edge



Fig. 22
Support Poles Affixed to Threaded Insert Nuts



Fig. 23
Backboard Hardware Kit

STEP FOUR: (Requires hardware from B-Ball box #1 - See Fig. 23) Pass 3/8" x 5" T bolt through back side of Slam Jam bracket. "T" part of bolt will nestle in indentation of bracket. Align the 4 holes in this assemble with the 4 matching holes in backboard. Pass four (4) 5/16" x 2" bolts through from front. After bolts pass through backboard but before cross piece, insert a plastic spacer on each side. After cross piece, attach four (4) 5/16" hex flange nuts. (See Fig. 24) Hand tighten only.

STEP FIVE: Pass 3/8" x 5" T bolt through center hole of rim. Install Slam Jam reinforcement bracket next on T bolt. (Bent part of bracket faces rim and flat part faces spring.) The rim spring is added next, followed by the 1-1/2" washer, then the special 3/8" nut. (See Fig. 25) Install the net to the rim at this time.

NOTE: This assembly provides the breakaway feature of the rim and will be adjusted later in assembly.



Fig. 24

T Bolt and Slam Jam Bracket Shown



Fig. 25

Rim Installation Shown

STEP SIX: Place an escutcheon on each deck pole bottom, ensuring that the escutcheon is oriented correctly. Insert a deck anchor into the bottom of each deck pole bottom. Orient deck anchors in poles (as shown in Fig. 26) so the single deck flange hole is facing toward the pool and the other 2 holes in the deck flange are facing away from the pool.

Pass the 1/4" x 2-1/4" bolt through the holes using a flat washer on each side of the post and hand tighten the nut.

STEP SEVEN: With 2 people, carefully stand the basketball assembly upright and in position on the deck. (See Fig. 27) None of the fasteners are tight at this point, so the assembly will have some flexibility. Make sure the set back from pool edge is 18" and the distance between poles is 16" on center. Mark the 3 flange hole locations for each pole. Move the assembly and using a 3/8" masonry bit, drill each hole 2" deep. Clean out each hole to allow wedge anchors to fully recess the full 2". Use 3/8" wedge anchors supplied in kit WS-DM. (See Fig. 28)

STEP EIGHT: Tighten all other hardware at this time except the rim spring T bolt and nut. Place black caps on top of each support pole.

STEP NINE: Adjust rim tension by turning the special nut tightener on the T bolt. The adjustment range will be from bolt flush with top of nut (most tension) to bolt about 3/8" short of top of nut (least tension).

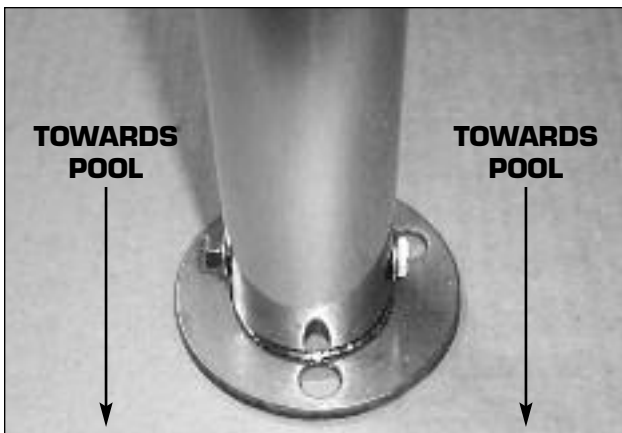

Fig. 26

On Deck Anchor with Flange

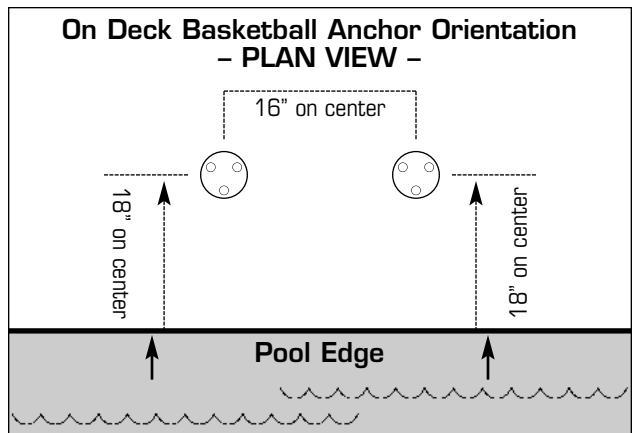

Fig. 27

On Deck Anchor Orientation

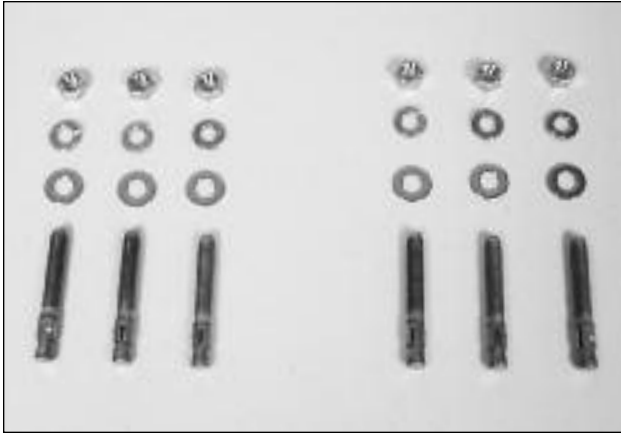

Fig. 28
Hardware Kit WS-DM Shown

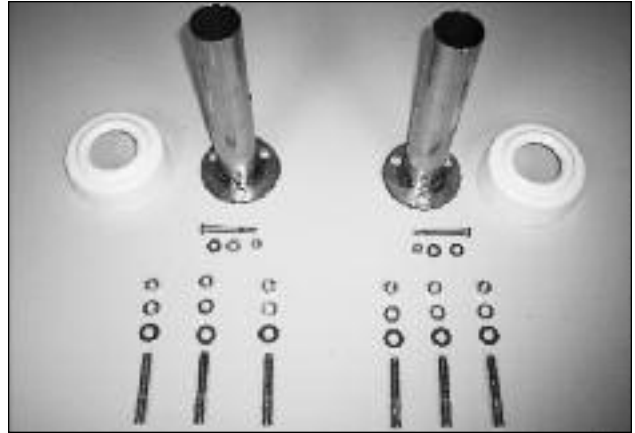

Fig. 29
On Deck Anchors, Escutcheons, Hardware

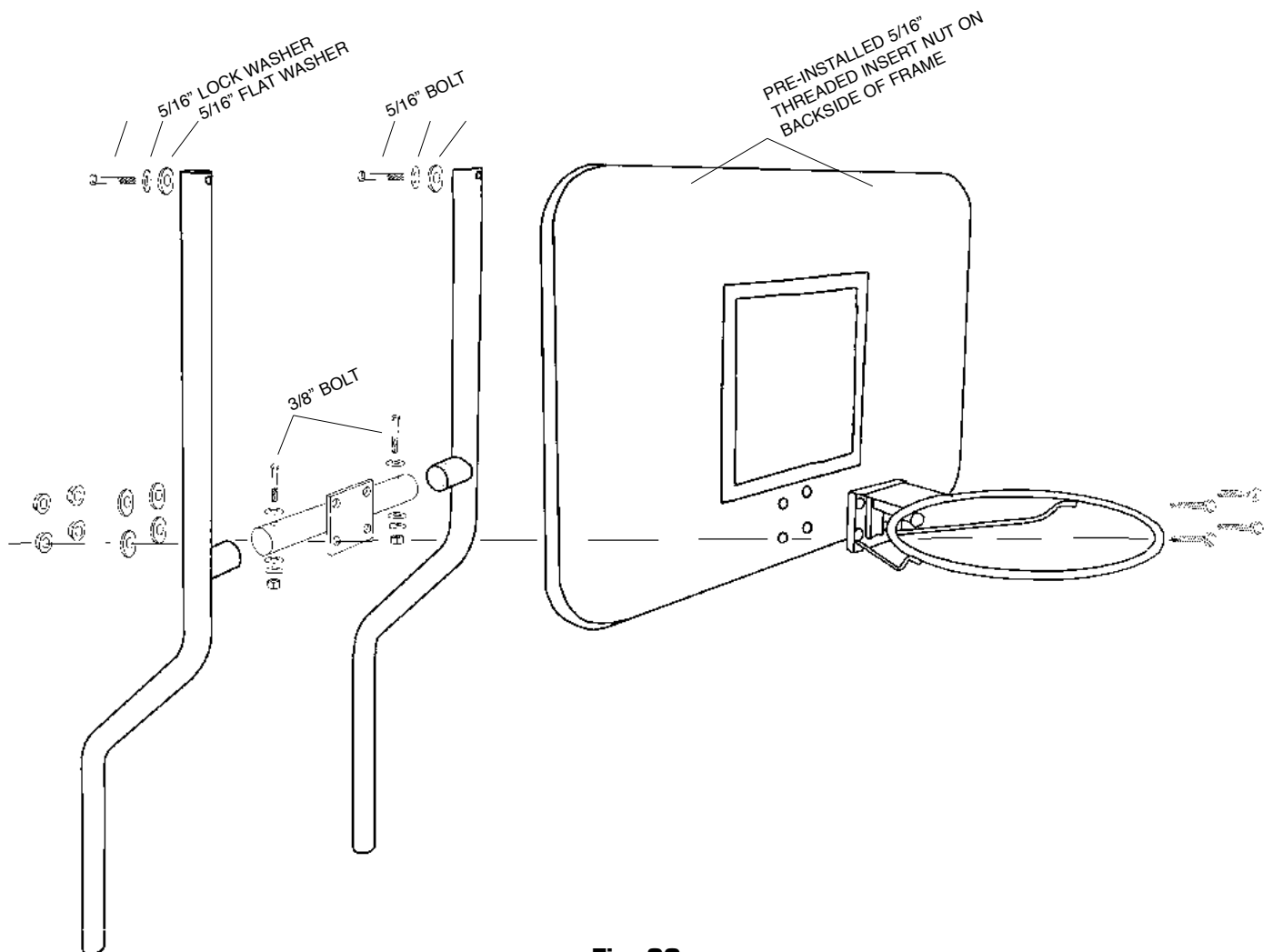

Fig. 30
Exploded View of All Parts for Basketball Set

LIMITED WARRANTY

Inter-Fab, Inc. will repair or replace, at its option, any product manufactured by Inter-Fab, Inc. that fails during the applicable warranty period because of a manufacturing or material defect; provided that the defect is not the result of improper installation, improper use or care, negligence, alterations or modifications to the product, or natural accidents (acts of God). The applicable warranty period for products manufactured by Inter-Fab, Inc. is three (3) years from the date of retail purchase, except as specified below:

Echoes of Nature™ products are individually handcrafted and painted by skilled artisans and as a result, dimensional differences and color variations are normal and are not a basis for warranty coverage. The warranty period for pumps sold with the Echoes of Nature™ products is three (3) years from the date of retail purchase.

Water Sports™ sports equipment warranty periods are as follows: Volleyball Poles, Basketball Poles, Basketball Rim, and Basketball Backboard are one (1) year from date of retail purchase. Volleyball, Volleyball Net, Basketball, Basketball Net, and pumps are warranted for ninety (90) days from date of retail purchase.

The Board Fall, Board Fall-L (LED), and Board Fall-F (fiber optic) water features, used for the **Jump & Splash™**, **T7™** and **aquaBoard™** products, have a warranty period of one (1) year from the date of retail purchase.

Zoomerang™ slide products warranty period is one (1) year from the date of retail purchase.

Build Your Own Slide™ (BYOS™) and **Build Your Own Slide 2™** (BYOS 2™) warranty periods are one (1) year from the date of retail purchase.

City 2™ Slide and **City Base™** products warranty period are one (1) year from the date of retail purchase.

Unless expressly stated otherwise all products manufactured by Inter-Fab are for **residential installation (single family residence)** inground pool use only. Inter-Fab, Inc. expressly disclaims any and all warranties and liability arising from the installation or use of its residential products for any non-residential use such as semi-public, public, or commercial applications. Products expressly manufactured for commercial installation and use will be subject to this limited warranty.

This limited warranty is in lieu of all other warranties, whether express or implied. Inter-Fab, Inc. disclaims any warranty of merchantability or fitness for a particular use, and noninfringement in relation to any of its products and Inter-Fab, Inc. is not liable for consequential, incidental or specific damages. This warranty is limited to the repair or replacement of the manufacturing or material defect, or refund of the original purchase price, whichever is less, at the sole option of Inter-Fab, Inc., and expressly does not cover any labor or reinstallation expenses related to the replacement of any and all Inter-Fab products. This limited warranty shall be the sole and exclusive remedy of irrespective of whether the claims are made in contract, tort, warranty, law, equity or by statute.

This warranty is to the original purchaser of the product only. Inter-Fab's limited warranty is neither transferable nor portable from consumer to consumer. The effective coverage date begins at the date of retail purchase. Product owner or representative must notify Inter-Fab, Inc. (or its wholesale agent) in writing, giving a full description of the nature of the product defect or failure along with proof of purchase, serial number(s) of the product and photos within thirty (30) days of the expiration of the applicable warranty period. Inter-Fab, Inc. reserves the right to physically inspect damaged or defective products or components to determine the cause of the damage or defect, prior to authorizing repair or replacement of its products.



3050 S. Alvernon Way • Tucson, AZ 85713

520.790.7040 • 800.737.5386 • Fax 520.790.7127 • inter-fab.com